

1. Do not touch the mirror with wet hands or wipe the the mirror with a damp cloth to avoid increasing the moisture pouring in;
2. Keep the mirror away from salt, grease and acid, which can corrode the mirror;
3. The mirror should be wiped with soft dry cloth or cotton to prevent the mirror from being brushed;
4. Use soft cloth or emery cloth, dip in some kerosene or wax to wipe;
5. Wipe the mirror and picture frame with a rag dipped in milk to make it clear and bright;
6. Before washing bath, soap can be daubed mirror, then wipe with dry cloth, the mirror on the formation of a soap liquid film, can prevent mirror blur;
7. Dip in a dry cloth with proper amount of detergent and smear it on the mirror surface, evenly wipe it off. The active ingredients in the detergent,
8. Astringent toner or detergent can also be used;
9. Use oil absorbent paper to rub.

Model:803336

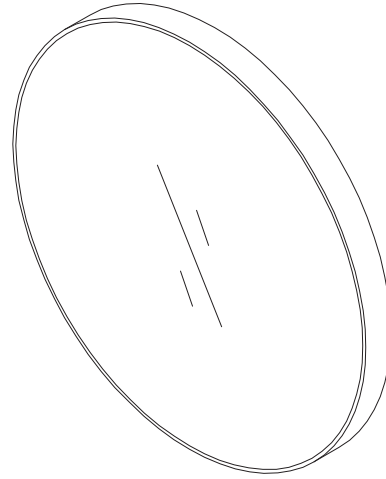

Erecting Tool



Parameters that

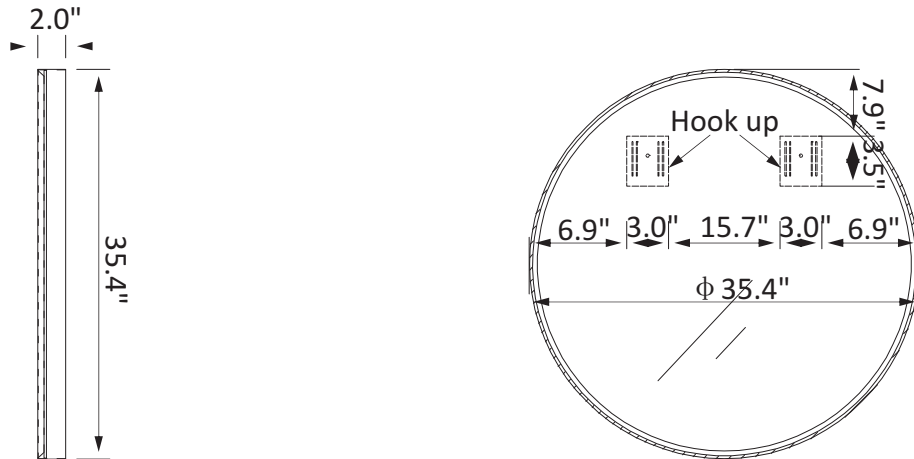

Installation steps

